

# Tradeflame®

## SOLDERING IRON - 8W / 11W

### PRODUCT MANUAL

PART NO. 218034

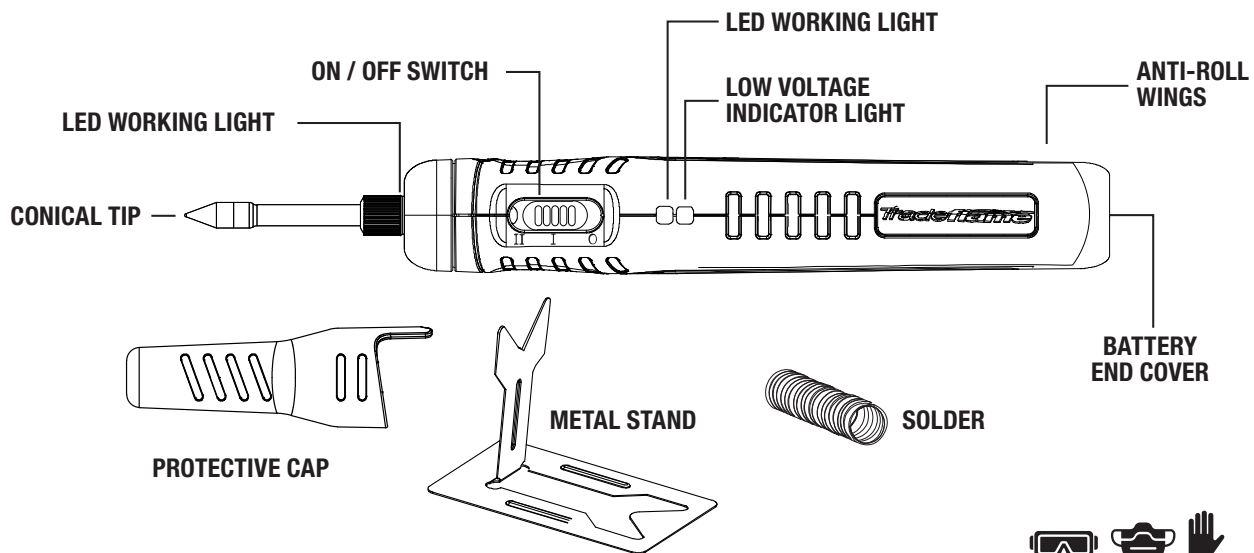

**CAUTION:** For maximum protection, always wear safety goggles, gloves or other appropriate equipment

#### SAFETY WARNINGS

Read all safety warnings, instructions, illustrations and specifications provided with this Soldering Iron. Failure to follow all instructions listed below may result in electric shock, and/or serious injury. Save all warnings and instructions for future reference. The term "Soldering Iron" in the warnings refers to your mains-operated (corded) Soldering Irons or battery-operated (cordless) Soldering Irons.

#### WORK AREA SAFETY

- Keep work area clean and well lit. Cluttered or dark areas invite accidents.
- Do not operate Soldering Iron in explosive atmo-liquids, gases or dust. Soldering Irons create sparks which may ignite the dust or fumes.
- **Keep children and bystanders away while operating**

#### ELECTRICAL SAFETY

- Indoor use. Do not expose Soldering Iron to rain or wet conditions. Water entering a Soldering Iron will increase the risk of electric shock

#### PERSONAL SAFETY

- Stay alert, watch what you are doing and use common sense when operating a Soldering Iron. Do not use a Soldering Iron while you are tired/distracted or under the influence. A moment of inattention while operating a Soldering Iron may result in serious personal injury.
- Use personal protective equipment. Always wear eye protection. Protective equipment such as a dust mask, non-skid safety shoes, hard hat or hearing protection used for appropriate conditions will reduce personal injuries.
- **Prevent unintentional starting. Ensure the switch is in the off position before connecting to power source, picking up or carrying the Soldering Iron.**
- **Place protective cap over a cooled tip** locking switch in off position.
- Do not overreach. Keep proper footing and balance at all times. This enables better control of the Soldering Iron in unexpected situations.
- Dress properly. Do not wear loose clothing or jewellery. Keep your hair and clothing away from moving parts. Loose clothes, jewellery or long hair can be caught in moving parts.
- Do not let familiarity gained from frequent use of the Soldering Irons allow you to become complacent and ignore Soldering Iron safety principles. A careless action can cause severe injury within a fraction of a second.

#### SOLDERING USE AND CARE

- Do not force the Soldering Iron. Use the correct Soldering Iron for your application. The correct Soldering Iron will do the job better and safer at the rate for which it was designed.
- Do not use the Soldering Iron if the switch does not turn it on and off. Any Soldering Iron that cannot be controlled with the switch is dangerous and must be replaced.
- Disconnect the plug from the power source and/or turn off the battery, from the Soldering Iron before making any adjustments, changing accessories, or storing Soldering Iron. Such preventive safety measures reduce the risk of starting the Soldering Iron accidentally.

- Store idle Soldering Iron **out of the reach of children** and do not allow persons unfamiliar with the Soldering Iron or these instructions to operate the Soldering Iron. Soldering Irons are dangerous in the hands of untrained users.
- Remove batteries from Soldering Tool if being stored for a long period.
- Maintain Soldering Iron and accessories. Check for misalignment or binding of moving parts, breakage of parts and any other condition that may affect the Soldering Iron's operation. If damaged, have the Soldering Iron repaired before use. Many accidents are caused by poorly maintained Soldering Iron.
- Use the Soldering Iron, accessories and Soldering Iron bits etc. in accordance with these instructions, taking into account the working conditions and the work to be performed. Use of the Soldering Iron for operations different from those intended could result in a hazardous situation.
- Keep handles and grasping surfaces dry, clean and free from oil and grease. Slippery handles and grasping surfaces do not allow for safe handling and control of the Soldering Iron in unexpected situations.
- Do not expose a Soldering Iron to fire or excessive temperature. Exposure to fire or temperature above 130°C (265°F) may cause explosion.

#### SPECIFIC SAFETY RULES FOR SOLDERING IRONS

- Contact with a hot tip could ignite flammable materials. Contact with a hot tip could ignite a fire.
- Do not stand or store tool upright on the battery pack. The Soldering Iron could tip resulting in contact between hot tip and flammable materials. Always set/store Soldering Iron on its side.
- Do not place Soldering Iron in coil stand. Place on its side when not in use.
- Keep hands clear of the tip serious burns can occur if skin contacts tip.
- Work in well ventilated areas. Soldering can produce fumes and smoke.
- Use personal protective equipment when using
- This Soldering Iron is not intended for use by persons (including children) with reduced physical, sensory or mental capabilities, or lack of experience and knowledge, unless they have been given supervision or instruction concerning use of the appliance by a person responsible for their safety. **KEEP AWAY FROM CHILDREN**
- To reduce the risk of fire, personal injury, and product damage due to a short circuit, never immerse your Soldering Iron, battery pack or charger in fluid or allow a fluid to flow inside them. Corrosive or conductive fluids, such as seawater, certain industrial chemicals, and bleach or bleach-containing products, etc. can cause a short circuit.
- To reduce the risk of injury, always wear safety goggles or glasses with side shields. Serious burns could occur if skin contacts a hot tip.

#### ACCESSORIES

Use only recommended accessories. Others may be hazardous.  
For a complete listing of accessories, go online to [www.tradeflame.com](http://www.tradeflame.com)

# Tradeflame®

## SOLDERING IRON - 8W / 11W

### PRODUCT MANUAL

PART NO. 218034

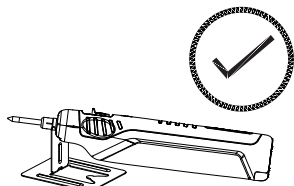

Correct storage of Soldering Iron when not in use.

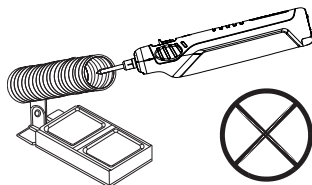

Do not place in coil holder.

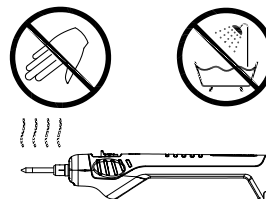

**WARNING** Hot tip when in use, do not touch, keep Soldering Iron clean and away from oils and lubricants. Do not immerse Soldering Iron in water.

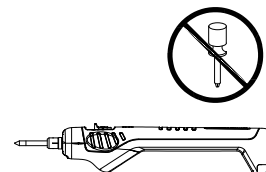

Do not modify or attempt to repair the Soldering Iron except as indicated in the instructions for use and care.

#### CHANGING THE SOLDERING TIP

Ensure the tip is cool and Soldering Iron is switched off and the tip temp indicator off before touching the tip as serious burns could occur to skin if touched

1. Loosen the sleeve counter clockwise.

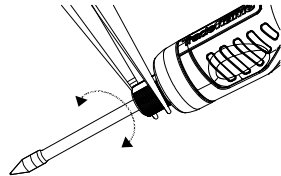

2. Remove the tip and replace.

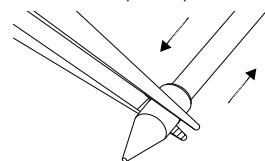

3. Tighten the sleeve securely clockwise.

#### SOLDERING HINTS

- Ensure the soldering tip and work items are clean.
- Re-tin the tip (cover the heated tip with solder) prior to use.
- Use the soldering iron to heat the work items and apply solder directly to the work items – not to the soldering iron tip.
- Clean the tip with a damp sponge or Tradeflame Brass Tip Cleaning Brass Wire (Part no. 218167) after use – do not file tip.

#### ASSEMBLY

- Remove battery end cover (Fig.1 / vi)
- Install 4 x 1.5V AA Alkaline batteries according to polarity diagram inside handle
- Refit cover.

**NOTE: BATTERIES NOT INCLUDED.**

#### OPERATION

1. Prepare the work area and piece
2. Make sure Soldering Iron tip is fixed in position and tightened.
3. Remove the Protective cap.
4. Slide On / off switch forward to turn on the Soldering Iron (Fig. 1 / iv).
5. Allow the tool to come to full temperature. Working light: indicates the iron has reached the default temperature for working
6. From 0 to I (low temperature 8 W), it takes approx. 30 seconds, the green light will flash until it reaches the pre-set working temperature. Green light will change to solid green when ready.
7. From I to II (low temperature 8 W to 11 W), it takes around 30 seconds, the red light will flash until it reaches the pre-set working temperature. Red light will change to solid red when ready.
8. When turning II to I, the green light will flash until it reaches the pre-set working temperature. Green light will change to solid green when ready.
9. Surfaces of the connection points must be clean.
10. "Tin" the tip by covering the heated tip with rosin core solder.
11. Use the Soldering Iron to heat the connection points, not the solder.
12. Apply only enough solder to the heated parts.
13. Allow the joint to cool undisturbed.
14. Low Voltage indicator light: Red light on when it is running out of battery.
15. To turn off the Soldering Iron, slide the, turn off tool by pressing back the On / off switch
16. While still hot, clean the tip with a lightly damp sponge or Tradeflame Brass Tip Cleaning Brass Wire (Part Number: 218167). **WARNING! Avoid contact, tip is hot and could cause serious burns.**
17. Place Soldering Iron on Metal Stand provided on its side with the tip away from working area Temp Indicator: Solid Red - Cooling Turn
18. Let the Soldering Iron to cool down naturally
19. Once tip has cooled place its Protective cap back on the Soldering Iron and store in a safe and dry space.