

WOOD BURNING KIT PRODUCT MANUAL

PART NO. 218134, 400145

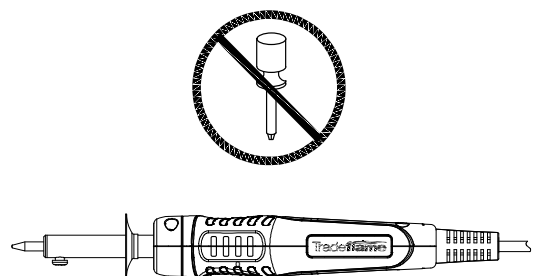

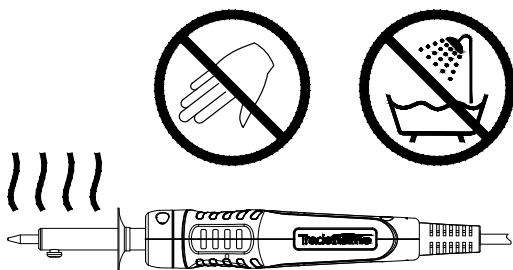
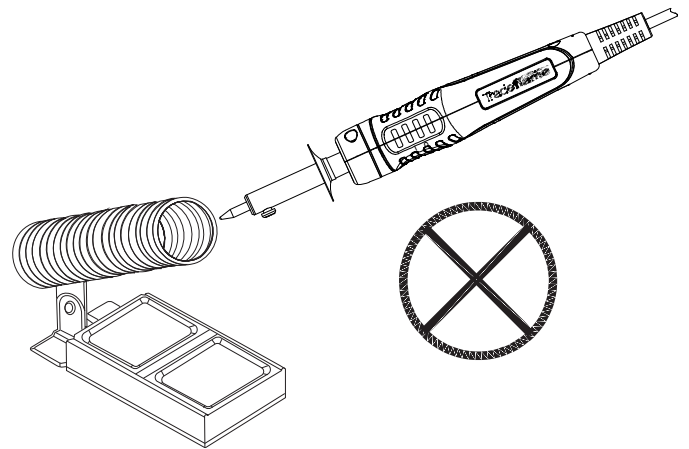
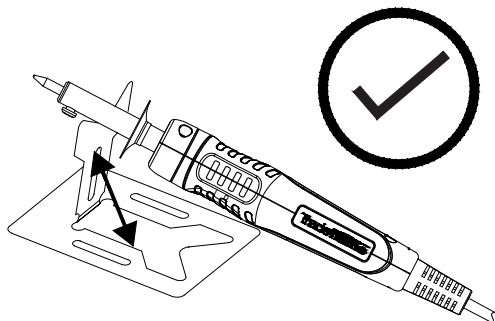
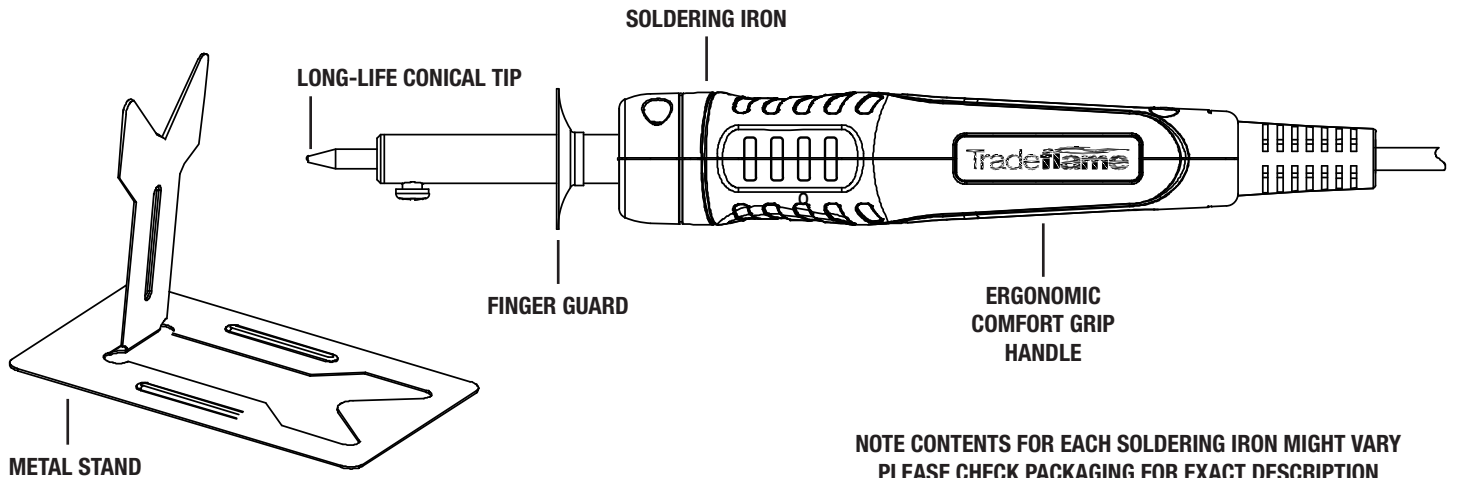

CAUTION: For maximum protection, always wear safety goggles, gloves or other appropriate equipment.

SAFETY WARNINGS

Your Tradeflame Soldering Iron is a very safe tool and complies with all the relevant safety regulations in Australia. Nevertheless, like all electrical appliances, it must be handled with care. **Read all safety warnings, instructions, illustrations and specifications provided with this Soldering Iron.** Failure to follow all instructions listed below may result in electric shock, and/or serious injury. Never forget that the soldering tip and heater can reach high temperatures. Follow these simple safety rules at all times. Keep Soldering Iron out of reach of children. Keep your Soldering Iron well away from all flammable material. To avoid burns, always assume that the tip is hot. Be sure the hot soldering tip and heater does not come into contact with the electric power cord. Before making any adjustment (removing or replacing a tip, etc.) make sure the iron is unplugged and cool. Do not dip the tool into any liquid. Always work in a well-ventilated area. After use, unplug the iron, allow the tip to cool, and store in a safe place. Safety goggles are recommended for preventing hot materials from injuring eyes. **Save all warnings and instructions for future reference.** The term "Soldering Iron" in the warnings refers to your mains-operated (corded) Soldering Irons or battery-operated (cordless) Soldering Irons.

WORK AREA SAFETY

- Keep work area clean and well lit. Cluttered or dark areas invite accidents.
- Do not operate Soldering Iron in explosive atmo-liquids, gases or dust. Soldering Irons create sparks which may ignite the dust or fumes.
- **Keep children and bystanders away while operating**

ELECTRICAL SAFETY

- Indoor use. Do not expose Soldering Iron to rain or wet conditions. Water entering a Soldering Iron will increase the risk of electric shock

PERSONAL SAFETY

- Stay alert, watch what you are doing and use common sense when operating a Soldering Iron. Do not use a Soldering Iron while you are tired/distracted or under the influence. A moment of inattention while operating a Soldering Iron may result in serious personal injury.
- Use personal protective equipment. Always wear eye protection. Protective equipment such as a dust mask, non-skid safety shoes, hard hat or hearing protection used for appropriate conditions will reduce personal injuries.
- **Prevent unintentional starting. Ensure the switch is in the off position before connecting to power source, picking up or carrying the Soldering Iron.**
- Do not overreach. Keep proper footing and balance at all times. This enables better control of the Soldering Iron in unexpected situations.
- Dress properly. Do not wear loose clothing or jewellery. Keep your hair and clothing away from moving parts. Loose clothes, jewellery or long hair can be caught in moving parts.
- Do not let familiarity gained from frequent use of the Soldering Irons allow you to become complacent and ignore Soldering Iron safety principles. A careless action can cause severe injury within a fraction of a second.

SOLDERING USE AND CARE

- Do not force the Soldering Iron. Use the correct Soldering Iron for your application. The correct Soldering Iron will do the job better and safer at the rate for which it was designed.
- Disconnect the plug from the power source before making any adjustments, changing accessories, or storing Soldering Iron. Such preventive safety measures reduce the risk of starting the Soldering Iron accidentally.
- Store idle Soldering Iron **out of the reach of children** and do not allow persons unfamiliar with the Soldering Iron or these instructions to operate the Soldering Iron. Soldering Iron are dangerous in the hands of untrained users.
- Maintain Soldering Iron and accessories. Check for misalignment or binding of moving parts, breakage of parts and any other condition that may affect the Soldering Iron's operation. If damaged, have the Soldering Iron repaired before use. Many accidents are caused by poorly maintained Soldering Iron.
- Use the Soldering Iron, accessories and Soldering Iron bits etc. in accordance with these instructions, taking into account the working conditions and the work to be performed. Use of the Soldering Iron for operations different from those intended could result in a hazardous situation.
- Keep handles and grasping surfaces dry, clean and free from oil and grease. Slippery handles and grasping surfaces do not allow for safe handling and control of the Soldering Iron in unexpected situations.
- Do not expose a Soldering Iron to fire or excessive temperature. Exposure to fire or temperature above 130°C (265°F) may cause explosion.

SPECIFIC SAFETY RULES FOR SOLDERING IRONS

- Contact with a hot tip could ignite flammable materials. Contact with a hot tip could ignite a fire.
 - While in use do not stand or store Soldering Iron on its side. Soldering Iron could tip resulting in contact between hot tip and flammable materials. Always set/store Soldering Iron on metal stand provided
 - Do not place Soldering Iron in coil stand
 - Keep hands clear of the tip serious burns can occur if skin contacts tip
 - Work in well ventilated areas. Soldering can produce fumes and smoke
 - Use personal protective equipment when using
 - This Soldering Iron is not intended for use by persons (including children) with reduced physical, sensory or mental capabilities, or lack of experience and knowledge, unless they have been given supervision or instruction concerning use of the appliance by a person responsible for their safety
- KEEP AWAY FROM CHILDREN**
- To reduce the risk of fire, personal injury, and product damage due to a short circuit, never immerse your Soldering Iron, battery pack or charger in fluid or allow a fluid to flow inside them. Corrosive or conductive fluids, such as seawater, certain industrial chemicals, and bleach or bleach-containing products, etc., can cause a short circuit
 - To reduce the risk of injury, always wear safety goggles or glasses with side shields. Keep hands and fingers behind finger guard. Serious burns could occur if skin contacts a hot tip

ACCESSORIES

Use only recommended accessories. Others may be hazardous.

For a complete listing of accessories, go online to www.tradeflame.com

CHANGING THE SOLDERING TIP

Ensure the tip is cool and Soldering Iron is switched off and unplugged from mains current before touching the tip as serious burns could occur to skin if touched.

1. Unscrew the nut and remove the nut and barrel.

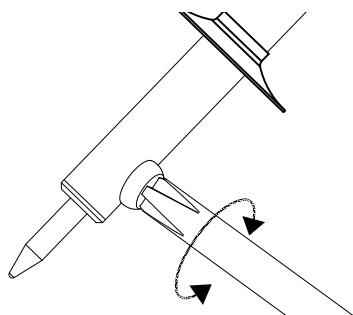

2. Remove the tip and replace.

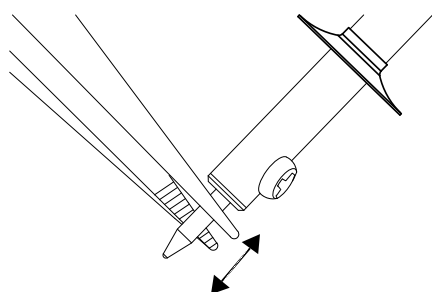

3. Reinstall the nut and barrel. Tighten the nut securely.

GETTING THE MOST FROM YOUR TRADEFLAME WOOD BURNING KIT

Tips, Tricks, and Techniques for Better Results

Pyrography is the correct term for the technique more commonly known as 'wood burning'. The term means the art of 'drawing with fire'. It is an ancient craft practiced throughout the world.

Originally pokers were heated in fires and created rather crude results. During the Victorian period the craft enjoyed its greatest popularity.

Victorian ladies developed various tools such as fine steel rods similar to knitting needles and heated them in a fire or over a spirit lamp, allowing them to work more skilfully and create fine designs. The rods would lose their heat quickly and have to be returned to the fire for reheating, making the process slow and tedious.

Today Pyrography is enjoying renewed popularity due to the advancement in wood burning irons, the variety of available tips and the vast assortment of surfaces to decorate.

Tip: When starting a new project, test the wood and the tips by writing your name on the back of the chosen piece of wood. This allows you to get a feel for how the wood will respond and to get your creative juices and technique flowing.

GETTING STARTED

Set up a safe work area. You can tape the iron holder to a piece of ceramic tile. The tile is heavy enough to keep the iron stand from tipping over while it protects the work surface. You will also need a fireproof container like a glass dish or metal lid to hold your various tips while they are cooling. You will need a pair of needle nose pliers with smooth jaws to remove the hot tips from the iron. Remember that metal conducts heat very quickly. Never attempt to change a hot tip with your fingers. Protect your work surface with aluminium foil, or a piece of plywood.

The best way to get started is to familiarize yourself with the iron, the various tips and the patterns they create. See the "Tips and Their Uses" section for an explanation of how to use each tip included with your new kit.

TIPS AND THEIR USES

- Your new TradeFlame Wood Burning Kit comes with a wide variety of burning, cutting, branding, and specialty tips depending on which kit you have purchased. To get the most from your kit, follow these instructions to create the results you want.
- **Universal tip** - A multi-purpose tip. Hold the tip at various angles for creating lines of varying widths. Performs all fundamental wood burning techniques.
- **Slanted tip** - Hold the tip at various angles for creating lines of varying widths.
- **Stencil tip** - Use this tip to cut craft pattern stencils into stencil materials.
- **Dot tip** - for making dots of various sizes and depths. Using this tip, make light touches to your surface for fine dots. Hold the tip on the surface for longer periods of time to create deep holes.
- **Script tip** - for writing script and for burning grooves of various depths. Move slowly across your work to make deeper grooves.
- **Calligraphy tip** - This tip mimics the shape of a calligraphy pen. Do not allow the iron to rotate in your hand as you trace calligraphy letters.
- **Flow tip** - Use to burn curves, dots, and fine details. Works well for cursive writing and dot shading techniques.
- **Shading/transfer tip** - this tip is tapered so that you can use it in several positions to create light and dark shading. The polished base slides smoothly and is great for general shading. Also can be used to transfer patterns. Edges can be used for thinner imprecise lines. The toe can be used for burning fatter imprecise lines. The inverted tip can be used for stippling.
- **Stripes Tip** - this tip is used to create stripes as required
- **Blade Tip** - To install the knife blade tip onto the iron, carefully insert the blade into the tool and tighten the screw to secure it in place. Use this specialty tip to cut foam, rope, or other soft rigid materials
- **Stamp tips** - Apply these various tips vertically on your project surface. Remove them in a straight vertical motion to make a distinct pattern. Use these separately or together to create interesting patterns and borders on multiple surfaces
- **Conical tip** - Used to convert the tool into a Soldering Iron. Use with lead-free solder to join metal.

PRACTICE

1. Plug in your wood burning iron and allow it about four minutes to heat up.
2. Hold the wood burner like a pencil. **Do not touch any of the metal parts, as they are hot.**
3. Start by writing your name. Practice pulling the point toward you instead of pushing it away.
4. You can vary the appearance of the pattern by the amount of time you leave the tip on the surface and by the pressure applied to the tip.
5. The longer the tip stays on the surface the deeper and darker the pattern will appear.
6. The brown shading is affected by the speed of the tip across the surface.
7. The smoother the surface of the material, the clearer and finer the design will appear.
8. After you have practiced a while, make a sample board as a reminder of patterns you can create using different tips and techniques.
9. This will make it fun and easy to complete a new project with an interesting display of 'pyrography techniques'.

PATTERNS ONTO YOUR PROJECT:

1. Make a copy of your pattern using a laser printer.
2. Place a copy face down on your project surface.
3. Fit the wood burning iron with the shading/transfer tip and allow the tip to heat to working temperature (about five minutes).
4. Using the shading/transfer tip slowly rub the back of the pattern in a circular motion to transfer the printed pattern to your project surface.
5. You can now burn your pattern into your project surface.
 - Keep your tips clean for good performance and long life. Carbon may build up on the tip surface as you work, especially if you're working with a sappy wood such as pine. Use a fine grit sandpaper or wire brush to gently clean the tips while they are hot.

DESIGNS

You can adapt a variety of designs from almost any media. From colouring books to garden manuals just about every item has been captured as line art or a simple sketch. Once you have become familiar with the iron and the patterns, you can create using the various tips, it will be easier for you to create your own designs. Use a copy machine to reduce and enlarge designs to suit your project.

TRANSFERRING DESIGNS

- Tools needed:
- Tracing paper
- Pencil
- Ruler
- Low tack masking tape
- Carbon paper

Place your pattern on the surface and secure with masking tape across the top. Lift the pattern and place the carbon paper directly on the surface. Reposition the pattern and lightly trace the design using a pencil. Double check your design before removing the pattern to make sure you have transferred the entire pattern. Use a ruler to trace straight lines.

SURFACES

A wide variety of surfaces are suitable for pyrography. Hardwoods such as beech, sycamore, birch and hornbeam are most popular. Most craft stores carry a good selection of these varieties. Birch plywood works well and is available at home improvement centres. You can also make your own tabletops and furniture using plywood and decorate it with your new skills. Smooth grained and light coloured woods work best. Stay away from dark, coarse grained hardwoods. Pines are not suitable because they have too much sap causing it to burn and mar your patterns. Cork, leather, some papers, and even wax candles make great design surfaces. Check your craft store and woodworking shops for suitable surfaces. Experiment! This is a hobby. That means you can just do it because it's fun.

SAFETY TIP

Caution should be taken when working with certain hardwoods such as, English pressure treated or tropical woods. Avoid using very thin plywood or veneer because they contain adhesives that emit dangerous fumes when heated. Wear protective masks.

ADDING COLOUR TO YOUR DESIGNS

Colour can add an extra element of excitement to your new project. The tips have provided great texture. Now it's time to add a finishing touch, once the pyrography is complete but before you varnish try some of these materials. Be sure to clean the surface first with a light rub of alcohol to remove fingerprints and grease.

Suggested colouring and finishing supplies:

- Varnish
- Acrylic paint thinned with water
- Coloured glazing gels
- Watercolours
- Caulks
- Wood stains and finishes
- Shoe polish
- Shoe dyes for a deep rich shade
- Paintbrushes with soft bristle
- Sponges for applying varnish
- Soft cloth

FINE GRIT SANDPAPER

Add a little water to your medium to keep it thin. Thick paint will cover up your pattern work. A foam plate makes a great pallet because there's no clean up and paints don't bleed into the surface. Test your colours and your technique on scrap materials if possible. If not, select the least visible location. Colour can be added to the designs as well as the background or both.

APPLYING VARNISH

Two to three coats of satin or gloss varnish will protect your work of art. Use a soft cloth or sponge rather than a brush, which might leave hairs and brush strokes behind. Follow manufacturer instructions regarding application, safety and drying times.

SOLDERING HINTS

- Re-tin the tip (cover the heated tip with solder) prior to use.
- Use the Soldering Iron to heat the work items and apply solder directly to the work items – not to the Soldering Iron tip.
- Clean the tip with a damp sponge or **Tradeflame Brass Tip Cleaner (Part number: 218167)** after use – do not file tip.
- Use the metal stand when Soldering Iron is not in use.

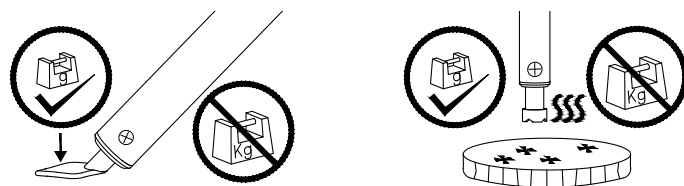

















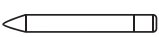







SOLDERING TIP:

OPERATING







1. Prepare the work area.
2. Ensure the Soldering Iron tip and work items are clean.
3. Make sure Soldering Iron tip is fixed in position and secure.
4. Connect Soldering Iron to mains current and place on the metal stand provided.
5. To turn on connect to power socket and turn on.
6. Allow the Soldering Iron to come to full temperature.
7. Surfaces of the connection points must be clean.
8. 'Tin' the tip by covering the heated tip with **Tradeflame Solder**.
9. Use the Soldering Iron to heat the connection points, not the solder.
10. Apply only enough solder to the heated parts.
11. Allow the joint to cool undisturbed.
12. To turn off the Soldering Iron, turn off power switch and unplug.
13. While still hot, clean the tip with a lightly damp sponge or **Tradeflame Brass Tip Cleaner (Part number: 218167)**.
WARNING! Avoid contact, tip is hot and could cause serious burns.
14. Place Soldering Iron on Metal Stand provided on its side with the tip away from working area.
15. Turn the mains current off and unplug the Soldering Iron.
16. Let the Soldering Iron to cool down naturally.
17. Once tip has cooled store in a safe and dry space.

WOOD BURNING KIT (Part No. 400145)

WOOD BURNING TIPS	
Universal Tip	
Slanted Tip	
Stencil Tip	
Dot Tip	
Script Tip	
Calligraphy Tip	
Flow Tip	
Shading Tip	
KNIFE TIP	
Blade Tip	
SOLDERING TIP	
Conical Tip	

STAMP TIPS	
Windmill Tip	
Hexagonal Tip	
Square Tip	
Triangle Tip	
Wheel Tip	
Stripe Tip	
Dart Board Tip	
S Shape Tip	
Star Tip	
Moon Tip	
Thumbs Up Tip	
Okay Tip	
Swirl Tip	
Wave Tip	
Stripes Tip	

WOOD BURNING KIT - 8 PIECE (Part no. 218134)

WOOD BURNING TIPS	
Universal Tip	
Dot Tip	
KNIFE TIP	
Blade Tip	
STAMP TIPS	
Windmill Tip	
Hexagonal Tip	
SOLDERING TIP	
Conical Tip	

Trade flame

Distributed by Tradepem Industrial Pty Ltd.